

**M12 male 90° / M8 female 0°**

PVC 3x0.25 ye UL/CSA 1m

Male 90° – female straight

M12 – M8, 3-pole

Plastic housings with good resistance against chemicals and oils.

The resistance to aggressive media should be individually tested for your application. Further details on request.

Further cable lengths on request.

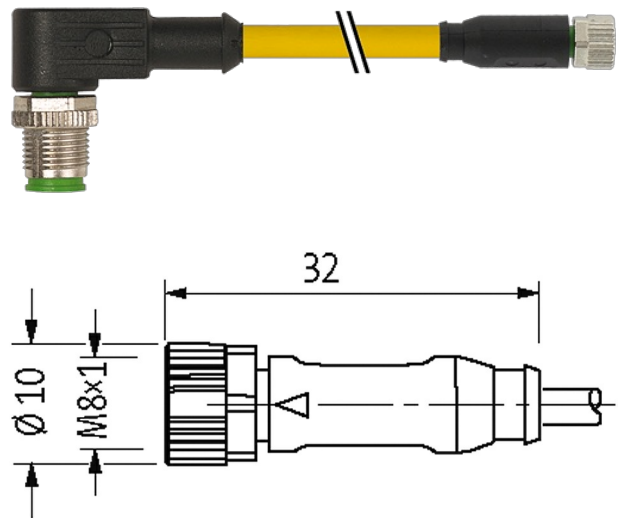
[Link to Product](#)**Illustration**

Product may differ from Image

**Approvals**

cCSAus



\* only for products with UL/CSA approved cable

**Form**

Form 40661

**General data**

Temperature range -25...+85 °C, depending on cable quality

**Cables**

No./diameter of wires	3 x 0.25 mm <sup>2</sup>
Wire isolation	PVC (br, bl, bk)
Jacket Color	yellow
Material (jacket)	PVC (UL/CSA)
Outer Ø	4.5 mm ±5%
Bend radius (moving)	10× outer Ø
Temperature range (fixed)	-30...+80 °C
Temperature range (mobile)	-5...+80 °C
Cable identification	010
Cable Type	1 (PVC)

Approval (cable)	UL (AWM-Style 2464/1731), CSA
Cable weight [g/m]	29,37
Material (wire)	Cu wire, bare
Resistor (core)	max. 79 $\Omega$ /km (20 °C)
Single wire $\varnothing$ (core)	0.15 mm
Construction (core)	14 x 0.15 mm (multi-strand wire class 5)
Diameter (core)	3 x 0.25 mm <sup>2</sup>
AWG	similar to AWG 24
Material (wire isolation)	PVC
Material property (wire isolation)	CFC-, cadmium-, silicone- and lead-free
Shore hardness (wire isolation)	45 $\pm$ 5 D
Wire- $\varnothing$ incl. isolation	1.25 mm $\pm$ 5%
Color/numbering of wires	br, bk, bl
Stranding combination	3 wires twisted
Shield	no
Material (jacket)	PVC
Material property (jacket)	CFC-, cadmium-, silicone- and lead-free
Shore hardness (jacket)	85 $\pm$ 5 A
Outer- $\varnothing$ (jacket)	4.5 mm $\pm$ 5%
Color (jacket)	yellow
chemical resistance	good resistance to oil, gasoline and chemicals
thermal resistance	flame retardant UL 1581 VW1 / CSA FT1
Nominal voltage	UL 300 V AC
Test voltage	2000 V AC
Current load capacity	to DIN VDE 0298-4
Temperature range (fixed)	-30...+80 °C
Temperature range (mobile)	-5...+80 °C
Bend radius (fixed)	5 x outer $\varnothing$
Bend radius (moving)	10 x outer $\varnothing$

#### Technical Data

Locking of ports	Screw thread (M8/M12 x 1 mm) recommended torque 0.4/0.6 Nm, self-securing
Operating voltage	max. 250 V AC/DC
Operating current per contact	max. 4 A
Protection	IP66K, IP67 inserted and tightened (EN 60529)
Rated surge voltage	1.5 kV

#### Commercial data

country of origin	DE
customs tariff number	85444290
EAN	4048879295970
eClass	27279218
Packaging unit	1

#### Sketch

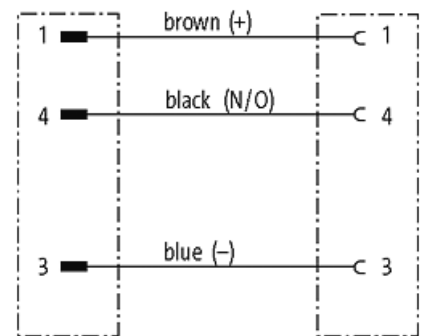
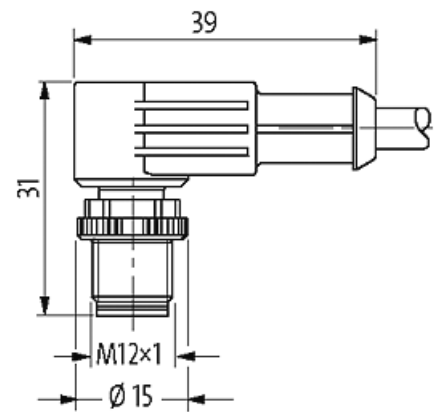

Male

Female

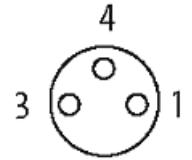
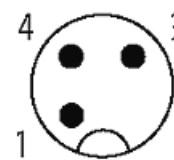

Product may differ from Image